

LMD-2451MT

Medical 3D LCD Monitor

SONY
make.believe



In recent years, digital technologies for stereoscopic three dimensional (3D) image processing and monitoring have progressed rapidly. This is particularly true of 3D imaging for medical use.

Some types of 3D monitoring systems are already used in medical modality applications. However, most of these are based on SD (standard-definition) resolution. Today's users are unhappy with this level of 3D picture quality and the way it compromises the usability of conventional 3D monitoring systems for endoscopic surgery. Newer systems which incorporate improved digital technologies for 3D monitoring, including HD (high-definition) resolution, are of greater value in medical modality applications.

Now, Sony introduces a high-performance medical 3D LCD monitor – the LMD-2451MT, 24-inch*¹ WUXGA (1920 x 1200 pixels) resolution monitor – to its comprehensive lineup of medical-grade displays.

The LMD-2451MT incorporates a circular-micro polarizer filter attached to the LCD panel, and is supplied with circular-polarizer 3D glasses. Wearing these lightweight 3D glasses*², users experience a feeling of natural depth, and smooth, uninterrupted viewing of multiple monitors and flicker-free 3D images. This image quality helps users to engage in 3D operations with minimal stress.

Installing an optional BKM-250TG 3G-SDI input adaptor, this 3D monitor offers a variety of 3D display functions such as Disparity Simulation, a Checkerboard Display, L/R Switch, and more to support optimum 3D settings and adjustments.*³

Not only does the LMD-2451MT deliver 3D imaging capabilities, but it also can be used as a 2D monitor and its features are upper-compatible with those of the current LMD-2450MD and LMD-2451MD medical monitors.

With these features and benefits, the LMD-2451MT is ideal for 3D endoscopic surgery and suited to a wide range of medical settings, such as conferences, education, and training, where critical high-quality 3D monitoring is required.

*¹ 24-inch (613.2-mm) viewable area, measured diagonally.

*² Two types of 3D glasses are available – the BKM-30G and BKM-31G (clip-on type) – weighing approximately 18 g (0.63 oz) and 16 g (0.56 oz) respectively.

*³ The BKM-250TG input adaptor (serial number 7100001 or later) is required.



Stereoscopic 3D Display Mechanism and Types

A human estimates the depth of an observed object using elements (depth cues) such as focus, perspective, interposition (occlusion), relative size, and other cues. The mechanism for displaying a 3D stereoscopic image is vergence and stereopsis.

Different types of 3D display systems are available – those that require glasses, and those that do not. There are different types of glasses-less systems: a lenticular system, parallax barrier system, and integral system. However, most of these systems cannot deliver viewing angles particularly in multiple view that are good enough for professional use. For this reason, glasses-less systems are usually only found today, for example, in amusement applications.

Currently there are two types of glasses-based systems: one is a shutter system typical of commercially available consumer televisions, for example, and the other is a circular-polarizer system which is incorporated in Sony professional and medical 3D monitors including the LMD-2451MT.

Benefits of Circular-polarizer 3D System

The circular-polarizer 3D glasses do not require synchronization with the monitor system – even if it is a multi-monitor system. Users experience smooth, uninterrupted viewing of multiple monitors, and flicker-free viewing even under a fluorescent light. Added to this, there is no need for batteries in the glasses, which are therefore very lightweight, and cross-talk (interference between right and left lenses) rarely occurs even when the wearer inclines their head.

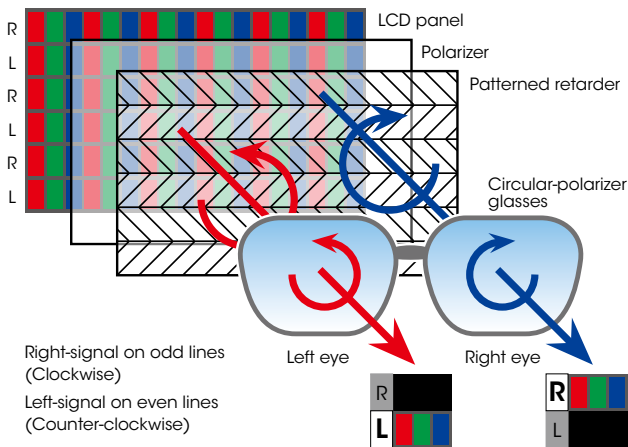

Principle of 3D Circular-polarizer

Unique Lightweight Circular-polarizer 3D Glasses

Two types of 3D glasses are available, the BKM-30G and BKM-31G (clip-on type), both of which are designed for the 3D operator's convenience and optimized for the LMD-2451MT Medical 3D monitor.

The BKM-30G is extremely lightweight – just 18 g (0.63 oz) approximately – and is comfortable to wear. The soft frame and center-support structure are designed to fit any size and shape of head and face, so the wearer experiences minimal

stress even during continuous medical tasks.

In addition, the center-support structure does not put the lenses under stress, and so there is no lens distortion. These polycarbonate lenses withstand temperature changes and shock. The ear stems maintain a comfortable and secure grip, preventing the glasses from slipping, and the nose pads also provide good grip even when sweat could cause slippage.

BKM-31G clip-on glasses are for operators who wear glasses for eyesight correction. They are very light, weighing only 16 g (0.56 oz) approximately.

Both the BKM-30G and BKM-31G circular-polarizer glasses block approximately 99% of the sun's ultraviolet rays.*

* BKM-30G and BKM-31G circular-polarizer glasses cannot be used as sunglasses. The blocked spectral range is 280 nm to 380 nm.



Multiple 3D Input Signal Formats and Interfaces

The LMD-2451MT accepts a variety of 3D signal formats including 3G-SDI (level-B), Dual-stream HD-SDI, HD-SDI Side-by-side, HD-SDI Line interleave (line-by-line), HD-SDI Field sequential using an optional BKM-250TG 3G-SDI input adaptor, and DVI Line interleave (line-by-line). This input flexibility enables versatile 3D system installation.

3D Signals and Video Formats

3D Signal type	3G (Level B) Dual stream	Side-by-side*4	Line interleave (Line-by-line)		Field sequential
Interface	3G-SDI*1 2 x HD-SDI*1	HD-SDI*1	HD-SDI*1	DVI	HD-SDI*1
1080/50i	Yes	Yes	–	–	–
1080/60i*2	Yes	Yes	–	–	–
1080/24p	Yes	Yes	Yes	–	–
1080/25p	Yes	Yes	Yes	–	–
1080/30p*2	Yes	Yes	Yes	–	–
1080/50p	–	–	Yes	–	–
1080/60p	–	–	Yes	–	–
1080/24PsF*2	Yes	Yes	–	–	Yes
1080/25PsF	Yes	Yes	–	–	Yes
720/50p*3	Yes	Yes	Yes	–	–
720/60p*2*3	Yes	Yes	Yes	–	–
1920 x 1080/50Hz	–	–	–	Yes	–
1920 x 1080/60Hz	–	–	–	Yes	–

*1 BKM-250TG (serial number 7100001 or later) is required for the 3D 3G/HD-SDI signals.

*2 The frame rate is also compatible with 1/1.001.

*3 720/50p and 720/60p signals are displayed as a native scan and in a window pattern.

*4 L/R pictures are displayed as a line-by-line in 3D mode. L/R pictures in 2D mode are displayed as a side-by-side display, and the L/R pictures are not compressed vertically.

Variety of 3D/2D Display Functions

There are a variety of convenient 3D display features such as Disparity Simulation, a Checkerboard Display, L/R Switch, Flip H, and Horopter Check.* These functions help optimize 3D settings and adjustments of the LMD-2451MT monitor before use. These capabilities are assignable to function keys on the front panel of the LMD-2451MT. This is very convenient for users who frequently switch between 2D and 3D mode during 3D operation.

* These functions work when the optional BKM-250TG 3G-SDI input adaptor is installed. Disparity Simulation, Checkerboard, and L/R Switch support only dual-stream HD-SDI signals, while Flip H and Horopter Check support both 3G-SDI (level-B) and dual-stream HD-SDI signals.

2D/3D Switching Function

This function helps users to monitor 2D/3D pictures by allowing switching during the same surgical procedure. It can be assigned to a function key (F1 as a default setting).

Disparity Simulation [3D mode]

Either the left or right signal phase (or both phases) of a 3D image can be shifted horizontally. In this way, users can simulate the amount of 3D image parallax, and can adjust for the most optimum 3D viewing.

* The simulated image cannot be output to other equipment, and cannot be recorded on an external recorder.

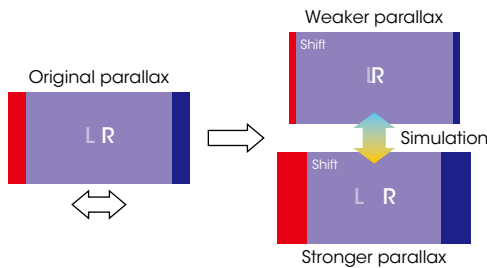

After Disparity Simulation, the last parallax value can be held and stored in memory. Both sides of the screen are masked with gray.

Checkerboard [2D mode]

Left and right input signals are displayed in a grid pattern on screen – divided into 9 blocks vertically and 16 blocks horizontally. By comparing adjacent images, users can recognize a difference in brightness and color setting of the left and right images, and thus easily adjust the camera's white balance and iris settings.

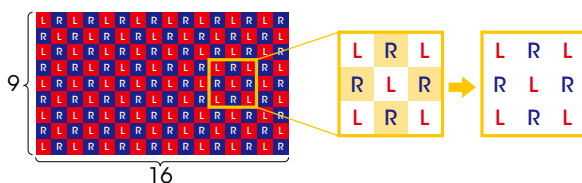

L/R Switch [2D mode]

Left and right signals can be swapped in a moment without inserting black frames, simply by manually pushing a function key. This instant-swap capability enables users to compare whole images and check for any sense of incongruity or for unnatural images.

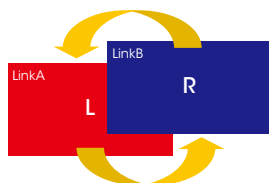

Other 3D Features

Flip H [3D mode]

The Flip H function turns the reversed image to the normal view when receiving a reverse image from a camera system.

* A delay in signal processing occurs, and both the left and right signals synchronize to the delayed signal.

Horopter Check [3D mode]

This function helps users to perceive the subtle difference of depth between different objects placed on the 3D screen surface.

Payload ID Display

Channel-assign information about the payload ID data of input signals is displayed on the menu screen. This tells users how the left and right channels are assigned in the menu.

3D/2D Color Matching Function (3D Offset Adjustment)

In 3D mode, this function offsets the white balance of a 3D image. This enables closer image color matching between a 3D image viewed through 3D glasses and a 2D image when the viewer takes off their 3D glasses. The benefit of this function is that surgeons can view and switch between 3D and 2D images without noticing color changes and therefore without feeling discomfort.

Vertical Viewing Angle in 3D Mode

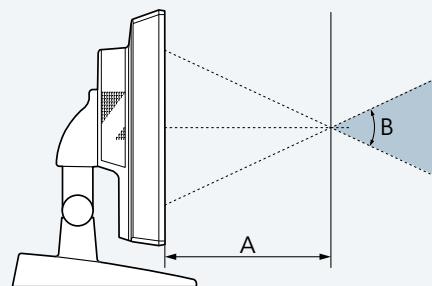

	A (minimum)	B (typical)
LMD-4251MT	300 mm	50°

Safety Listing and Compliance

The LMD-2451MT is UL60601-1 listed and complies with the CSA22.2 No.60601 and EN60 601-1 safety regulation. The monitor is suitable for use in professional medical applications.

High Performance WUXGA LCD Panel

The LMD-2451MT incorporates a high-contrast, high-brightness, and high-resolution WUXGA (1920 x 1200 pixels) LCD panel, which uses precisely manufactured RGB color filters, allowing the reproduction of colors with stunning depth and saturation to create highly natural images.

Incorporating an IPS panel, the LMD-2451MT offers stable images when viewed from various angles both horizontally and vertically*, with virtually no reduction in picture contrast, color saturation, or hue shift.

* The vertical viewing angle in 3D mode is 50° at a minimum distance of 300 mm from the center of the LMD-2451MT's screen.

**ChromaTRU™
Color Matching Technology**



For an extra level of color reproduction accuracy, every LCD panel used in the LMD-2451MT is precisely color-calibrated at the factory, providing faithful color reproduction, so that the R, G, B color coordinates are consistent for every monitor. Further to this, a second calibration is applied so that white balance is maintained at a consistent color temperature throughout all grayscale levels. Either ITU-R BT.709 or OFF can be selected for the color space settings.

White Balance Calibration Function

LCD monitor performance typically changes over time and requires regular recalibration to maintain its original performance.

The LMD-2451MT employs a software-based white balance calibration function, which is called LMD_AutoWhiteBalance. Combined with a PC and commercially available calibration tool*, this function enables simple adjustment of the monitor's white balance, even in a multiple monitor environment.

* The X-Rite Eye-one (i1) Pro Series.

Natural Gradation of Color Reproduction (10-Bit DSP)

The LMD-2451MT incorporates an advanced 10-bit digital video signal processor to produce accurate and lifelike images with smooth and natural gradation.

Sophisticated I/P (Interlace to Progressive) Conversion

The LMD-2451MT uses an advanced technology to perform sophisticated I/P conversion*, which is essential to enabling an interlaced video source to display on the LCD progressive panel. With this sophisticated I/P conversion technology, the LMD-2451MT does not need a scaling process to deliver essential high-level accuracy when monitoring detailed images from full-HD video sources.

* Three I/P conversion modes can be simply selected via the on-screen menu. In 3D mode, I/P conversion is fixed in Field-merge mode.

Color Temperature and Gamma Mode Selection

Users can select the color temperature from HIGH, LOW, LOW2, and USER modes. A gamma mode can also be selected from two settings: 2.2 and DICOM.

Why Black Bezel for Medical Monitor?

The LMD-2451MT incorporates a black-color bezel, instead of a conventional white one. This is simply because this monitor is designed to optimize surgeons' 3D image viewing, enabling them to concentrate on surgical procedures. The rear panel design is white, however, just like other medical monitors.



LMD-2451MT front



LMD-2451MT rear



LMD-2451MT side



LMD-2451MT sheet-type switches on the front bezel

Flat Front Panel Design

The LMD-2451MT is designed to eliminate difference in surface level between the monitor bezel and the protection panel. Also, by incorporating sheet-type switches in its front panel, this monitor prevents dust and contaminant build up, which is important for medical equipment hygiene.

Multi Picture-and-picture Capability

The LMD-2451MT provides a variety of input and output combinations for multi-display: Side-by-side (SBS), Picture-out-picture (POP), and Picture-in-picture (PIP). With the optional BKM-256DD DVI-D input adaptor, for example, the monitor can concurrently display two DVI input signal images. Also, in Side-by-side mode with vertical full scan, it is easier to diagnose captured moving images. These flexible display modes are convenient when displaying images from an endoscope, ultrasound, X-ray, and more. They also add convenience, allowing users to check captured images from an archive and still images on a printer.

Examples of multi-display

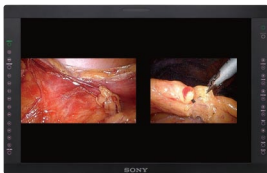

SBS (normal)

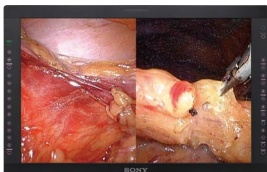

SBS (V-full scan)



POP (V-full scan)

* Simulated images

Scan Function

Scan size can be selected between "NORMAL (0%)", "OVER (20%)", "FULL", and "NATIVE*" scan modes. The aspect ratio can be switched between 16:9 and 4:3 according to the input signal.

* NATIVE is effective only when 1080i, 1080p, or 720p signal is input. 1080p can be selected when BKM-250TG is installed.

Mirror Image

The LMD-2451MT can reproduce a full-screen size, reverse image. This function is useful when it is impossible to physically turn an endoscopic camera system or when the camera system cannot deliver a reversed image. This Mirror Image function of the LMD-2451MT is ideal for procedures requiring two surgeons to work at opposite points of orientation to a patient, for example in thoracoscopic surgery, laparoscopic surgery, and other applications.

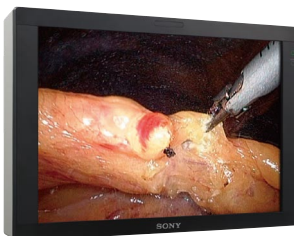

Normal image

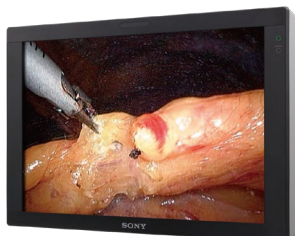

Mirror image

* Simulated images

User Memory Function

Users can save up to 20 picture settings, each with a user name. This data can be saved and loaded on the monitor or onto external equipment such as a PC connected in Serial Remote mode.

Power-saving Mode

When no input signal is received for over a minute, the monitor goes into power-saving mode and consumes minimal power. This function prevents unnecessary electrical consumption.

External Remote Control Function

The LMD-2451MT has an external remote control capability for input/output signal selection and adjustment of various items via Ethernet (10BASE-T/100BASE-TX) connection. Users can execute the same operation on all connected monitors, or put all connected monitors into the same setup and adjustment state.

Seven-language On-screen Display

The on-screen display is available in seven languages: English, French, German, Spanish, Italian, Chinese, and Japanese.

Mounting Flexibility (VESA)

The LMD-2451MT complies with the 100 x 100 mm hole-spacing VESA mounting standard, making it ideal for use with surgical equipment arms and tabletop stands. It is sufficiently flexible for use as a desktop monitor with an optional monitor stand, SU-560.



LMD-2451MT with a surgical equipment arm image



LMD-2451MT with an optional monitor stand SU-560

Key Inhibit Function

Key inhibit is a menu function that helps prevent inadvertent operation from the control panel. Users can also prevent this type of operator mistake just by pushing the Control button on the control panel; this turns off the LED switch lights, and cancels the switch functions.

Input Versatility

The LMD-2451MT monitor can accept almost any signal ranging from SD to HD video, as well as PC signals, via its DVI-D and HD15 connectors. In addition to standard inputs, a variety of different optional input adaptors are offered for use in the monitor's expansion slots. This versatility allows images to be monitored from a broad range of medical equipment sources.

Optional BKM-250TG Input Adaptor for 3G-SDI and 3D Display Functions

This interface is compliant with the SMPTE ST 424:2006 and ST 425:2008 (SMPTE 424M and 425) standards, transmitting up to 4:2:2/10-bit 1080/50p and 1080/60p video data using one SDI cable. It also supports 3G-SDI (level-B) and dual-stream HD-SDI – these signals are required for 3D display functions.

Optional BKM-256DD Input Adaptor for Dual DVI-D Inputs

By installing the optional BKM-256DD input adaptor in the monitor's expansion slot, users can employ a maximum of two DVI inputs and one loop-through output in a standard configuration.

• Equipped with DVI Signal Level Stable Circuit

The BKM-256DD is equipped with an equalizer circuit that enables the transfer of input signals over a long distance without signal deterioration. For optical fiber transmission, the 5 V power required to convert a signal from electric to optical is supplied from each 14-pin input and output connector.

Convenient Preset Function

In addition to typical signal formats, the LMD-2451MT supports a variety of video signal formats qualified by endoscopic manufacturers. The LMD-2451MT includes a table of seven types of preset to accommodate these video signal formats. Users can easily select from the on-screen display (OSD) menu their preferred monitor setting for each format.

Input Signals / Input Adaptors

Video Signal Formats	Interfaces					
	Composite Y/C	RGB Component	SDI 4:2:2	HD-SDI SD-SDI	3G/HD/SD-SDI (2D)	3G/HD/SD-SDI (3D)
	Standard		Options			
	BKM-227W	BKM-229X	BKM-220D	BKM-243HS	BKM-250TG	BKM-250TG
575/50i (PAL)	○	○	○	○	○	–
480/60i (NTSC) ^{*1}	○	○	○	○	○	–
576/50p	–	○	–	–	–	–
480/60p	–	○	–	–	–	–
1080/24PsF ^{*1}	–	○ ^{*2}	–	○	○	○
1080/25PsF	–	○ ^{*2}	–	○	○	○
1080/24p ^{*1}	–	○ ^{*2}	–	○	○	○
1080/25p	–	○ ^{*2}	–	○	○	○
1080/30p ^{*1}	–	○ ^{*2}	–	○	○	○
1080/50i	–	○	–	○	○	○
1080/60i ^{*1}	–	○	–	○	○	○
720/50p	–	○ ^{*2}	–	○	○	○
720/60p ^{*1}	–	○	–	○	○	○
1080/50p	–	–	–	–	○	–
1080/60p	–	–	–	–	○	–

*1 Compatible with 1/1.001 *2 For component input only

HD15 Input Signal Format

VESA	Resolution	Dot Clock [MHz]	fH [kHz]	fV [Hz]	Sync Polarity	
					Horizontal	Vertical
DMT	640 x 480 @60Hz	25.175	31.469	59.940	N	N
	800 x 600 @56Hz	36.000	35.156	56.250	P	P
	800 x 600 @60Hz	40.000	37.879	60.317	P	P
	800 x 600 @72Hz	50.000	48.077	72.188	P	P
	800 x 600 @75Hz	49.500	46.875	75.000	P	P
	800 x 600 @85Hz	56.250	53.674	85.061	P	P
	1024 x 768 @60Hz	65.000	48.363	60.004	N	N
	1024 x 768 @70Hz	75.000	56.476	70.069	N	N
	1024 x 768 @75Hz	78.750	60.023	75.029	P	P
	1024 x 768 @85Hz	94.500	68.677	84.997	P	P
	1152 x 864 @75Hz	108.000	67.500	75.000	P	P
	1280 x 960 @60Hz	108.000	60.000	60.000	P	P
	1280 x 1024 @60Hz	108.000	63.981	60.020	P	P

N = Negative P = Positive

VESA	Resolution	Dot Clock [MHz]	fH [kHz]	fV [Hz]	Sync Polarity	
					Horizontal	Vertical
CVT	640 x 480 @60Hz	23.625	29.531	59.780	P	N
	800 x 600 @60Hz	35.500	36.979	59.837	P	N
	1024 x 768 @60Hz	56.000	47.297	59.870	P	N
	1280 x 768 @50Hz	65.125	39.518	49.959	N	P
	1280 x 768 @60Hz	80.125	47.693	59.992	N	P
	1280 x 768 @60Hz	68.250	47.396	59.995	P	N
	1280 x 768 @75Hz	102.875	60.091	74.926	N	P
	1280 x 960 @60Hz	85.250	59.201	59.920	P	N
	1280 x 1024 @60Hz	91.000	63.194	59.957	P	N
	1360 x 768 @50Hz	69.500	39.489	49.922	N	P
	1360 x 768 @60Hz	84.625	47.649	59.936	N	P
	1360 x 768 @60Hz	72.000	47.368	59.960	P	N
	1920 x 1080 @50Hz	141.375	55.572	49.975	N	P
	1920 x 1080 @60Hz	138.625	66.647	59.988	P	N
	Others	720 x 400 @70Hz	28.322	31.469	70.087	N
1280 x 800 @60Hz		68.900	48.935	59.969	N	N

Range of DVI Input Signal

Max resolution: 1920 x 1080/60Hz

Vertical frequency: 50.0 Hz to 85.1 Hz

Horizontal frequency: 31.5 kHz to 77.0 kHz

Dot clock: 25.175 MHz to 148.500 MHz

Picture size, phase: automatically detected by the DE (data enable) signal

HD-SDI - Its Features and Benefits

HD-SDI is an interface to transmit high-definition (HD) video and audio signals in real time without failure. Because of this high-quality feature, HD-SDI has begun to penetrate medical facilities where high-resolution, high-quality image signal transmission is imperative. The interface connector is a BNC-type that is small in size and has a lock structure. The cable type is coaxial, which is comparatively thin and sufficiently flexible – a 5C-FV cable is an example. The transmission distance can be extended to approximately 100 m (328 ft) (typical)*, so this solution is suitable for cable installation inside a building.

The HD-SDI has 1.5 Gbps bandwidth to transmit Y/Cb/Cr 4:2:2 10-bit full-HD 1920 x 1080i signals. In addition, 3G-SDI featuring 3 Gbps bandwidth is also available to transmit Y/Cb/Cr 4:2:2 10-bit 1920 x 1080/50p and 60p signals. Both the HD-SDI and the 3G-SDI interface are ideal for high-definition (HD) image transmission, and they help in applications for minimally invasive (MI) procedures.

* The transmission distance differs according to cable type.



3G/HD-SDI interface image



8-bit (256-levels) image*



10-bit (1024-levels) image*

* Simulated images

Optional Accessories

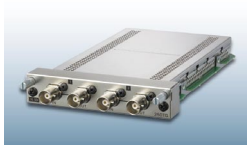

BKM-250TG

3G/HD/SD-SDI Input Adaptor



BKM-243HS

HD/SD-SDI Input Adaptor



BKM-256DD

DVI-D Input Adaptor



BKM-220D

SD-SDI 4:2:2 Input Adaptor



BKM-227W

NTSC/PAL Input Adaptor



BKM-229X

Analog Component Adaptor



SU-560

Display Stand



BKM-30G

Circular-polarizer 3D Glasses



BKM-31G

Clip-on type Circular-polarizer 3D Glasses

Optional Input Adaptors

BKM-250TG, 3G/HD/SD-SDI Input Adaptor*

3G/HD/SD-SDI signal input (x2)
3G/HD/SD-SDI monitor output (x2)

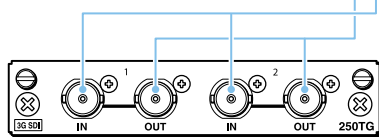

* 3G-SDI, HD-SDI and SD-SDI signals are detected automatically

BKM-243HS, HD-SDI/SD-SDI Input Adaptor*

HD-SDI/SD-SDI signal input (x2)
HD-SDI/SD-SDI monitor output (x1)

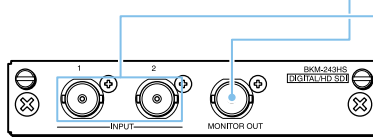

* HD-SDI and SD-SDI signals are detected automatically

BKM-256DD, DVI-D Input Adaptor

DVI-D signal input
DVI-D signal output

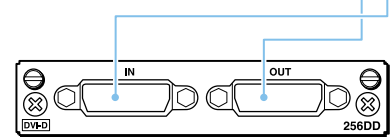

BKM-220D, SD-SDI 4:2:2 Input Adaptor

SD-SDI signal input (x2)
SD-SDI monitor output (x1)

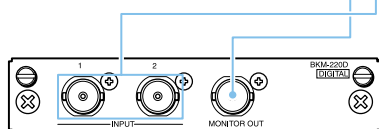

BKM-227W, NTSC/PAL Input Adaptor

Composite input/output (x1)
Y/C input/output (x1)

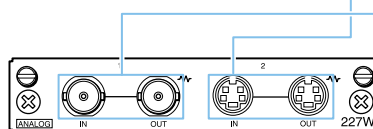

BKM-229X, Analog Component Adaptor

RGB, Y/PB/PR input (x1)
EXT SYNC (x1)

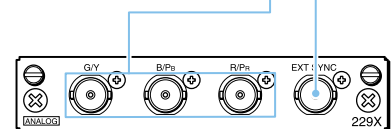

Specifications

LMD-2451MT	
Picture Performance	
Type	α-Si TFT Active Matrix LCD with an AR-coated protection panel
Resolution	1920 x 1200 pixels (WUXGA)
Effective picture size (H x W) (diagonal)	518.4 x 324.0 mm (20 1/2 x 12 7/8 inches) 613.2 mm (24 1/4 inches)
Aspect	16:10
Colors	Approx. 16.7 million colors (8-bit)
2D Viewing angle	89°/89°/89°/89° (typical) (up/down/left/right contrast > 10:1)
3D Viewing angle	50° at a viewing distance more than 300 mm, crosstalk less than 7% (typical)
Input (typical)	
Composite	BNC (x1), 1.0 Vp-p ±3dB sync negative
Y/C	Mini DIN 4-pin (x1) Y: 1.0 Vp-p ±3dB sync negative, C: 0.286 Vp-p ±3dB (NTSC burst signal level), 0.3 Vp-p ±3dB (PAL burst signal level)
RGB, Component	BNC (x3) RGB: 0.7 Vp-p ±3dB (sync on green, 0.3 Vp-p sync negative) Component: 0.7 Vp-p ±3dB (75% chrominance standard color bar signal)
DVI-D	DVI-D (x1), TMDS single link
HD15	D-sub 15-pin (x1), RGB: 0.7 Vp-p sync positive (sync on green, 0.3 Vp-p sync negative) Sync: Total level (polarity free, H/V separate sync) Plug & Play function: corresponds to DDC2B
External sync	BNC (x1) 0.3 Vp-p to 4.0 Vp-p ± bipolarity ternary or negative polarity binary
Option slot	2 slots
Parallel remote	Modular connector 8-pin (x1) (pin-assignable)
Serial remote	D-sub 9-pin (RS-232C) (x1), RJ-45 modular connector (Ethernet) (x1) (10BASE-T/100BASE-TX)
DC in	DC 5 V / 24 V (output impedance 0.05 ohms or less)
Output	
Composite	BNC (x1), Loop-through, with 75 ohms automatic termination
Y/C	Mini DIN 4-pin (x1), Loop-through, with 75 ohms automatic termination
RGB, Component	BNC (x3), Loop-through, with 75 ohms automatic termination
External sync	BNC (x1), Loop-through, with 75 ohms automatic termination
General	
Power requirements	DC IN: 24 V 5.0 A, 5 V 0.030 A (supplied from AC adaptor) AC adaptor (Sony, AC-110MD) AC IN: 100 V to 240 V, 50/60 Hz, 1.53 A to 0.58 A DC OUT: 24 V 5.0 A, 5 V 0.060 A
Power consumption	Maximum: approx. 136 W (with 2 x BKM-229X)
Operating temperature	0°C to 35°C (32°F to 95°F) Recommended: 20°C to 30°C (68°F to 86°F)
Operating humidity	30% to 85% (no condensation)
Storage and transport temperature	-20°C to +60°C (-4°F to +140°F)
Storage and transport humidity	0% to 90% (no condensation)
Operating, storage, and transport pressure	700 hPa to 1060 hPa
Dimensions (W x H x D)	602.4 x 386.2 x 110 mm (23 3/4 x 15 1/4 x 4 3/8 inches) (including projections)
Mass	8.8 kg (19 lb 6.4 oz) (with 2 x BKM-250TG) AC adaptor (AC-110MD) 1.2 kg (2 lb 10 oz)
Supplied accessories	AC adaptor (AC-110MD) (1), AC power cord (1), AC plug holder (2), 3D glasses (glasses-type) (1), 3D glasses (clip-on type) (1), L/R labels (1), Instructions for use (1), CD-ROM (1), Using the CD-ROM Manual (1), Quick Reference (1), When you First Use the Monitor (1), Sales Companies Guide (1), Warranty book (1)

Dimensions

Unit: mm (inches)

* With the SU-560 optional monitor stand.

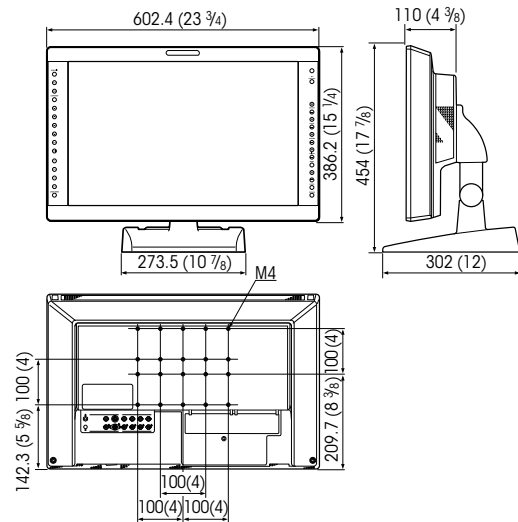

Front Panel

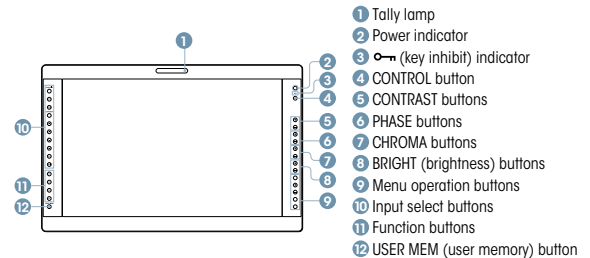

Connector Panel

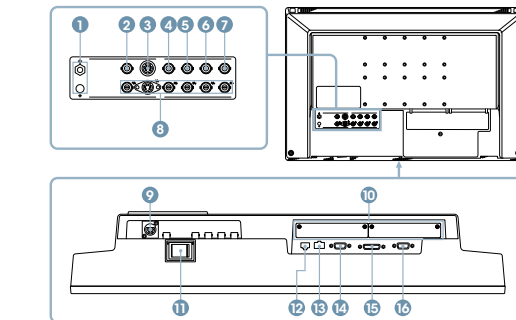

- 1 ⚡ (Equipotential/Function Earth) terminal
- 2 COMPOSITE IN connector (BNC)
- 3 Y/C IN connector (Mini DIN 4-pin)
- 4 G/Y IN connector (BNC)
- 5 B/PB IN connector (BNC)
- 6 R/PR IN connector (BNC)
- 7 EXT SYNC IN (external sync input) connector (BNC)
- 8 Loop-through output connectors
- 9 DC 5V/24V IN connector
- 10 Optional input slot
- 11 ⏻/⏪ (power) switch
- 12 PARALLEL REMOTE connector (modular connector, 8-pin)
- 13 SERIAL REMOTE connector (RJ-45)
- 14 SERIAL REMOTE RS-232C connector (D-sub 9-pin, female)
- 15 DVI-D input connector (DVI-D)
- 16 HD15 input connector (D-sub 15 pin, female)

Distributed by

©2010 Sony Corporation. All rights reserved.
Reproduction in whole or in part without written permission is prohibited.
Features and specifications are subject to change without notice.

Images on monitors are simulated.
The values for mass and dimension are approximate.
"SONY", "make.believe", and "ChromaTRU" are trademarks of Sony Corporation.
All other trademarks are the property of their respective owners.

This catalog is published for a worldwide audience and, as such, cannot reflect country-specific standards and regulations.